

KAZ Flower Fully Automated Torch

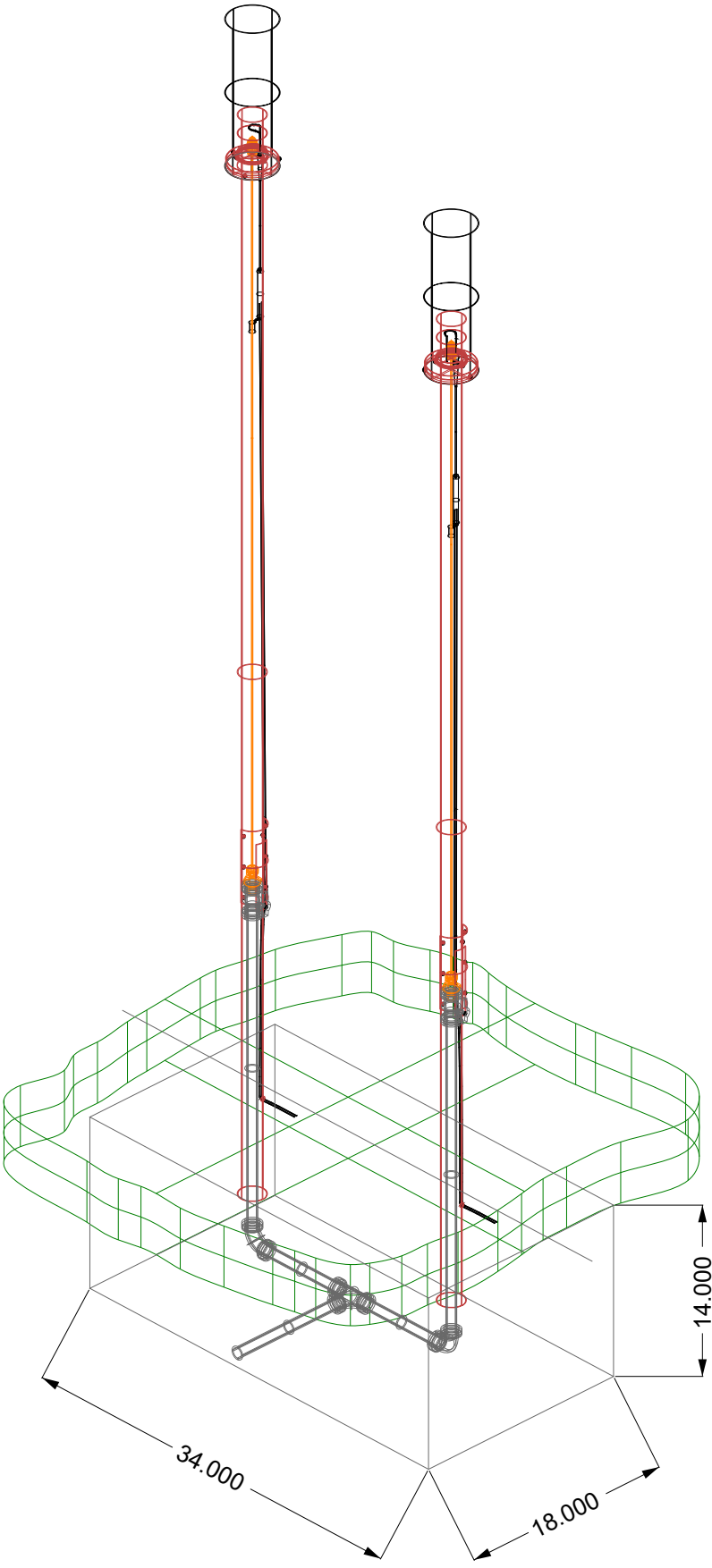

All Dimensions In Inches

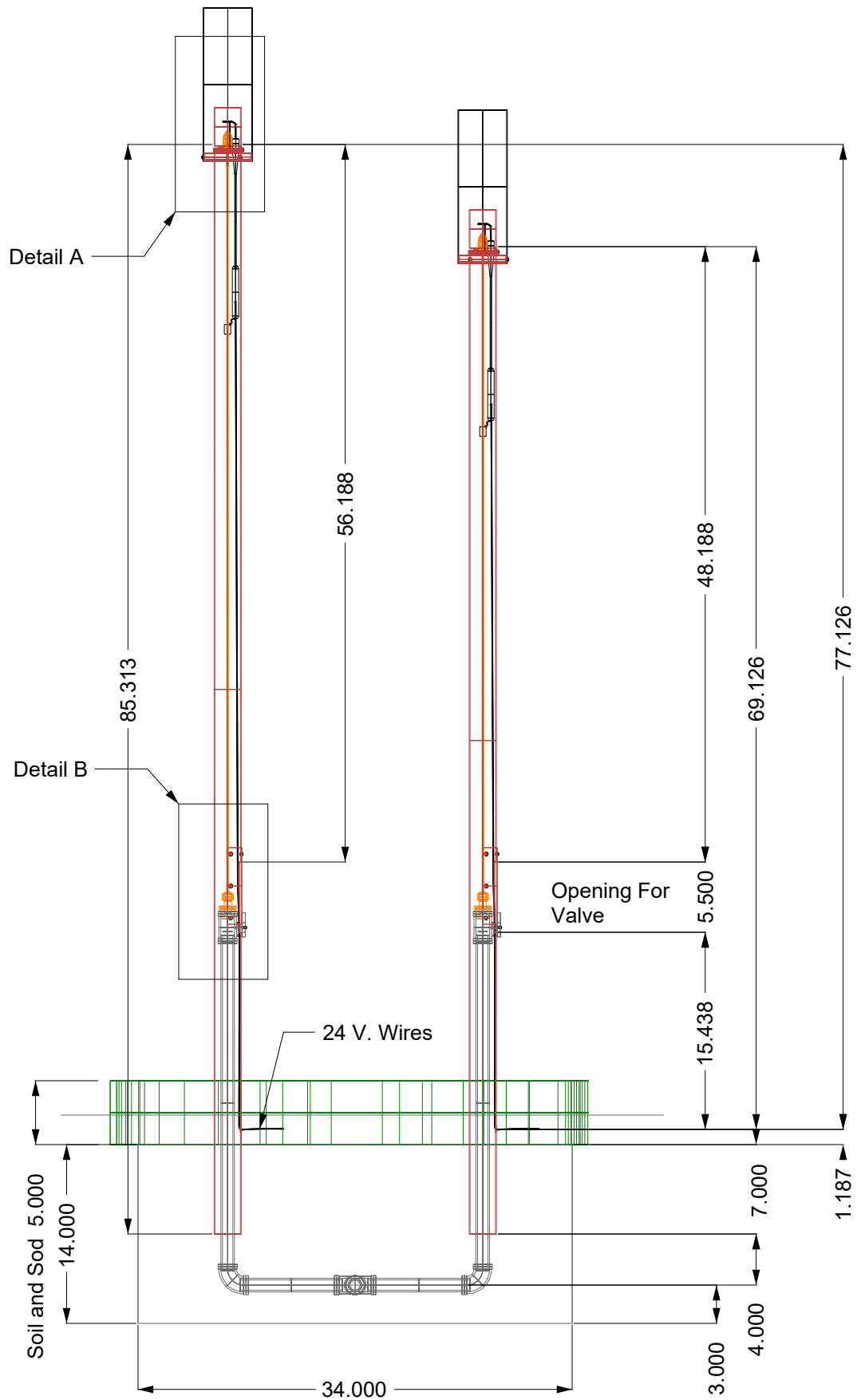

All Dimensions In Inches

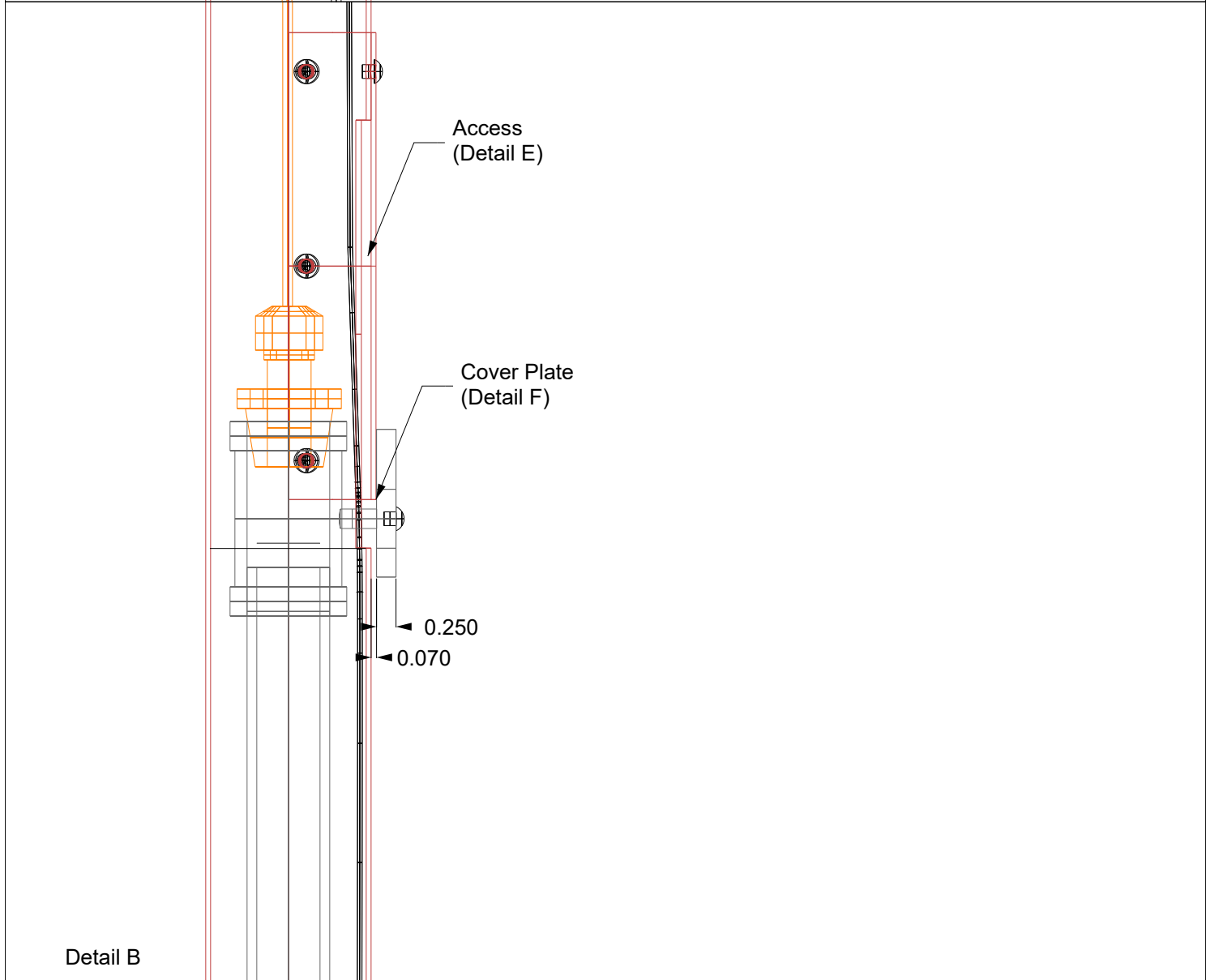
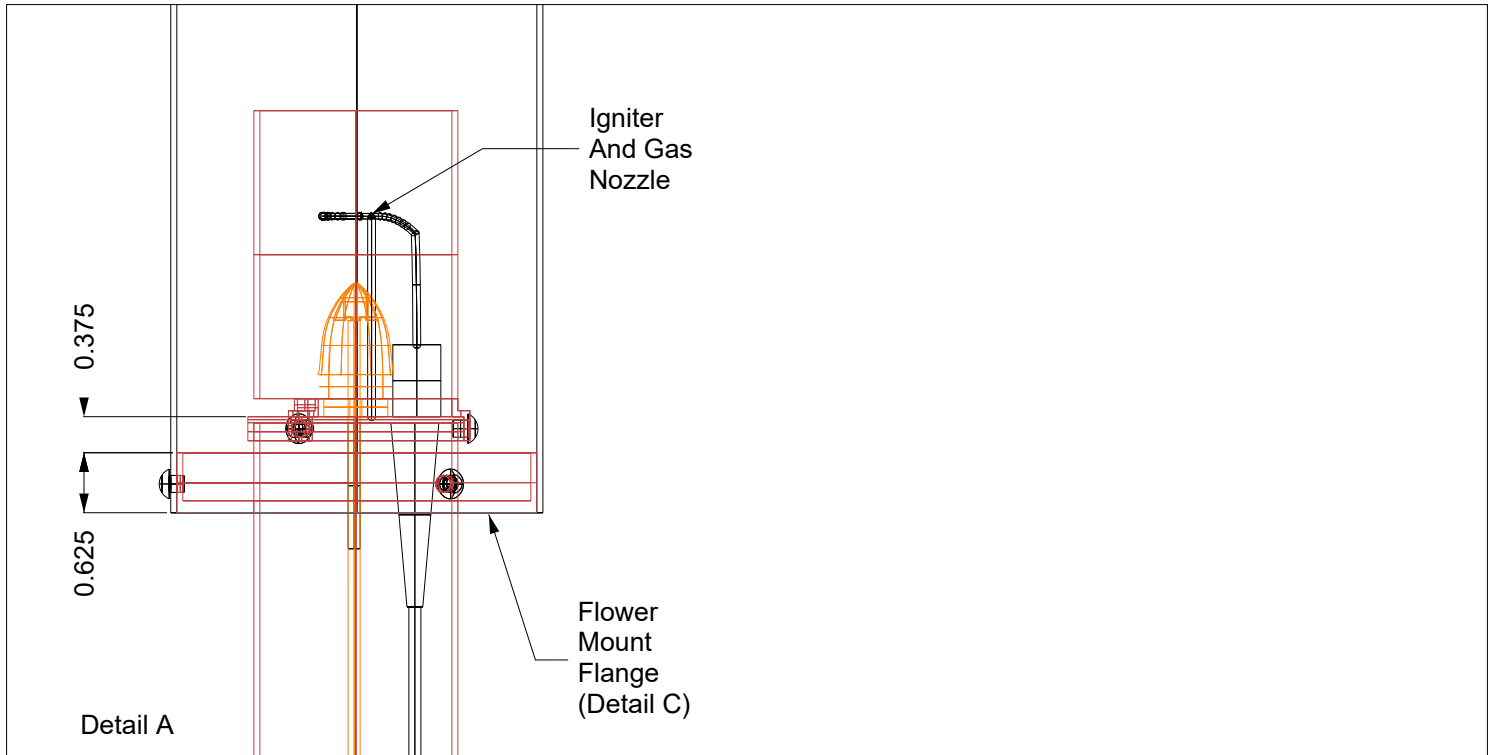

Tap For 8-32 Screw
3 Places, Eq. Spaces

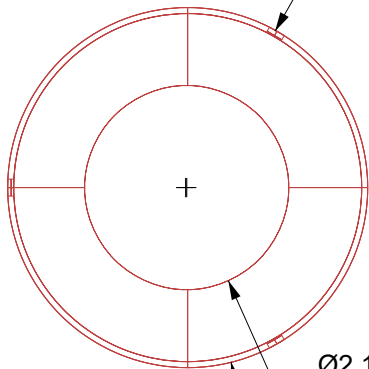

Flower
Mount
Flange
(Plan View)

Ø3.750

Ø2.125
Tack Weld
4 Eq Spaces

Tap For 8-32 Screw
3 Places, Eq. Spaces

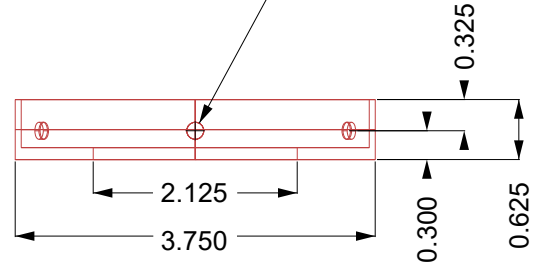

Flower
Mount
Flange
(Front View)

Detail C

Drill And Tap
8-32 Screw
7 Places

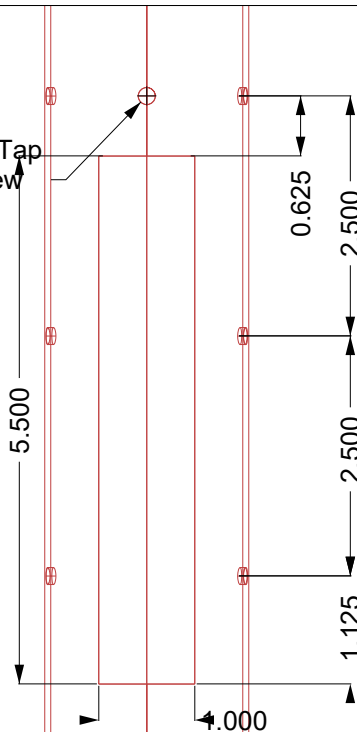

Access
(Front View)

Access
(Plan View)

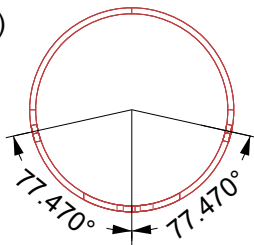

Detail E

Ø0.177 Clearance
For 8-32 Screw
7 Places

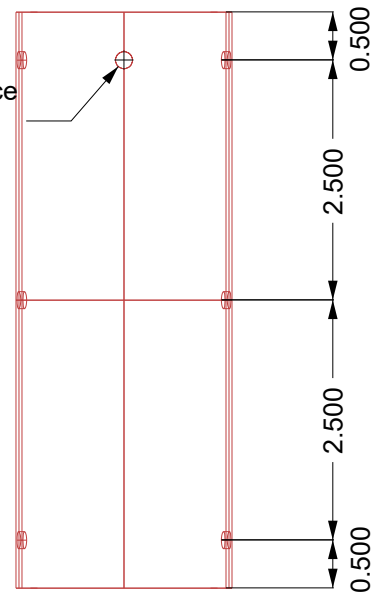

Cover Plate
(Front View)

Cover Plate
(Plan View)

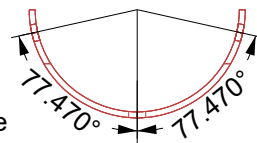

Detail F

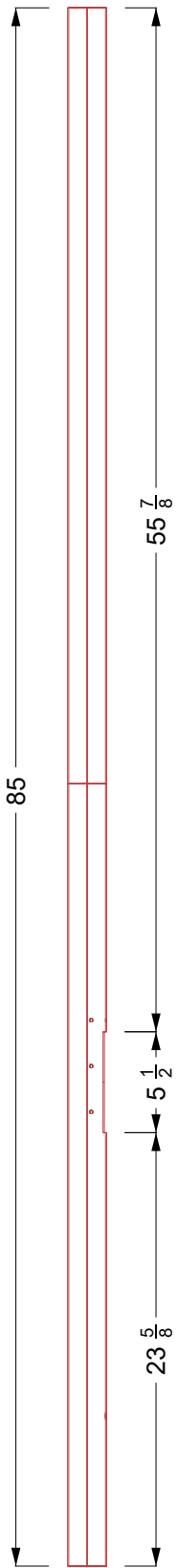

Tall Copper Tubing

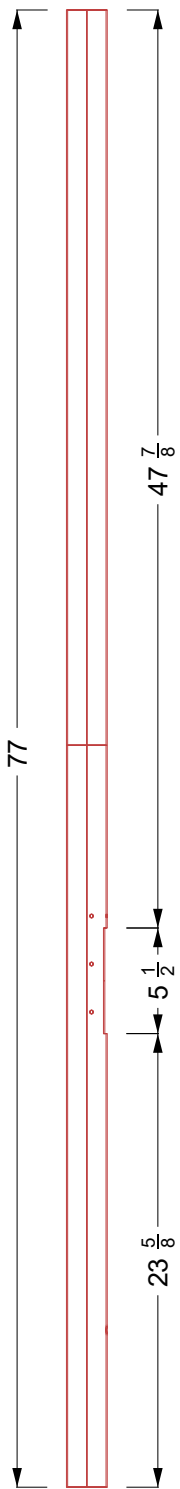

Short Copper Tubing

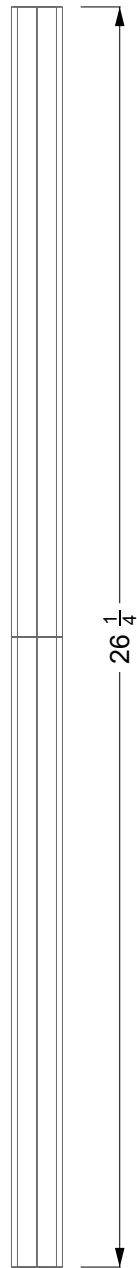

Vertical Pipe



Horizontal Pipe

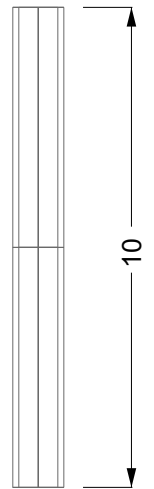

Feed Pipe